

LR03AD POWERLINE

DIMENSIONS (MM)

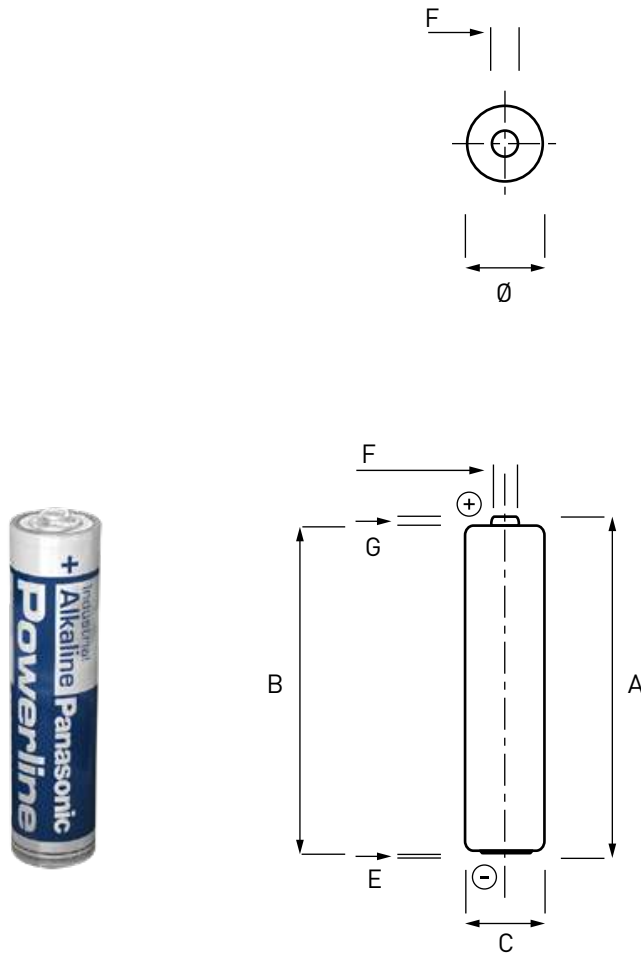

IEC dimensions	Maximum	Minimum
A	44.5	
B		43.5
C		4.3
E	0.5	
F	3.8	
G		0.8
Ø	10.5	9.5

Specifications	LR03 / S / AAA / AM4 / MICRO / MN2400 / 24A / 24AC
Made in	Belgium
Type	Alkaline Foil
Nominal voltage (V)	1.5
Electrolyte	Potassium Hydroxide
Average weight (g)	11.0
Storage temp. range	+10°C [50°F] ~ + 25°C [77°F]
Operating temp. range	-20°C [-4°F] ~ + 55°C [131°F]
Average Impedance	+/- 180 m-Ω @ 1kHz fresh
Heavy metals	No added Mercury (Hg), Cadmium (Cd) or Lead (Pb)
Compliant to	IEC 60086-1, IEC 60086-2, IEC 60086-5 non dangerous goods regulation EU directive 2006/66/EC Nordic Ecolabel
Recommended cut off voltage	0.8V per cell [0.9V per cell for multi series usage]

LR03AD POWERLINE

TYPICAL DISCHARGE VALUES

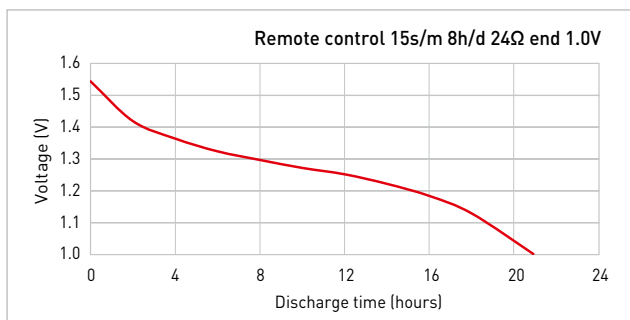
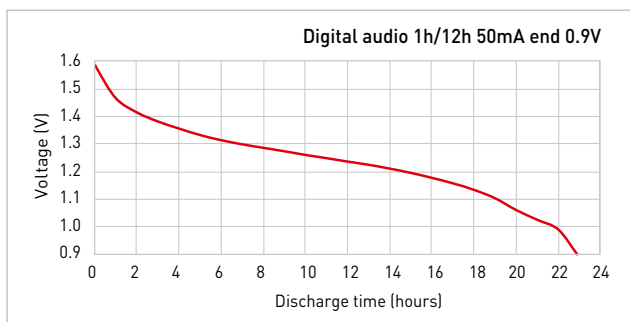
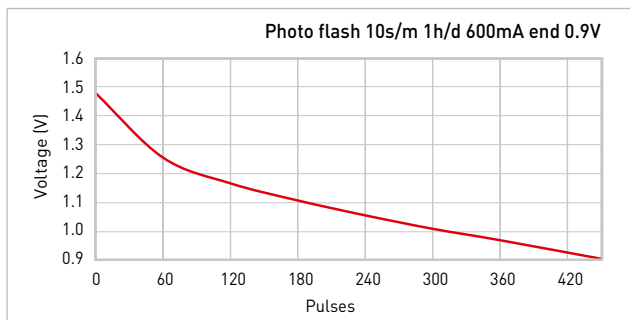
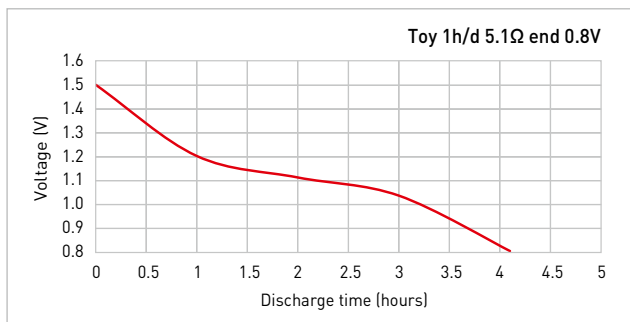
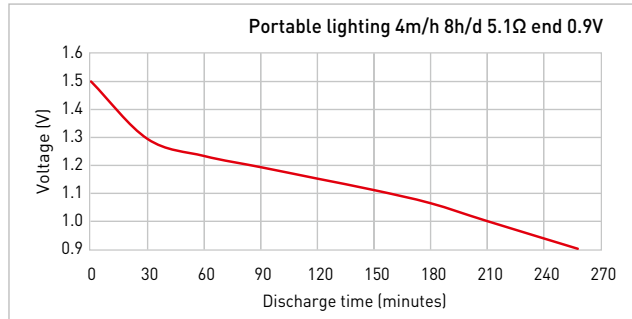
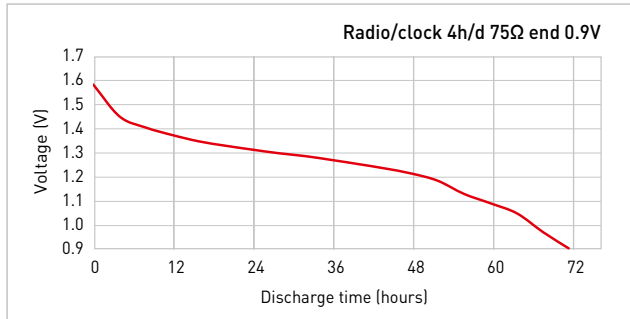

DISCHARGE TEMPERATURE CHARACTERISTICS

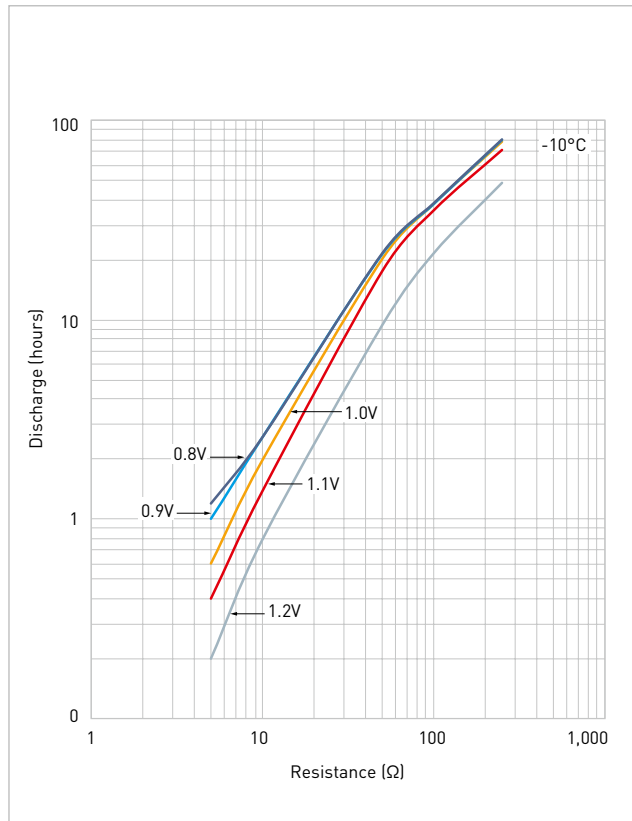

The information herein is believed to be correct. However no warranty is made, either expressed or implied, regarding the accuracy of the results to be obtained from the use of such information. Test results are strictly according to IEC conditions. Capacities of batteries depend on drain, temperature and cut-off voltage. Data are subject to change.

LR03AD POWERLINE

DISCHARGE TEMPERATURE CHARACTERISTICS

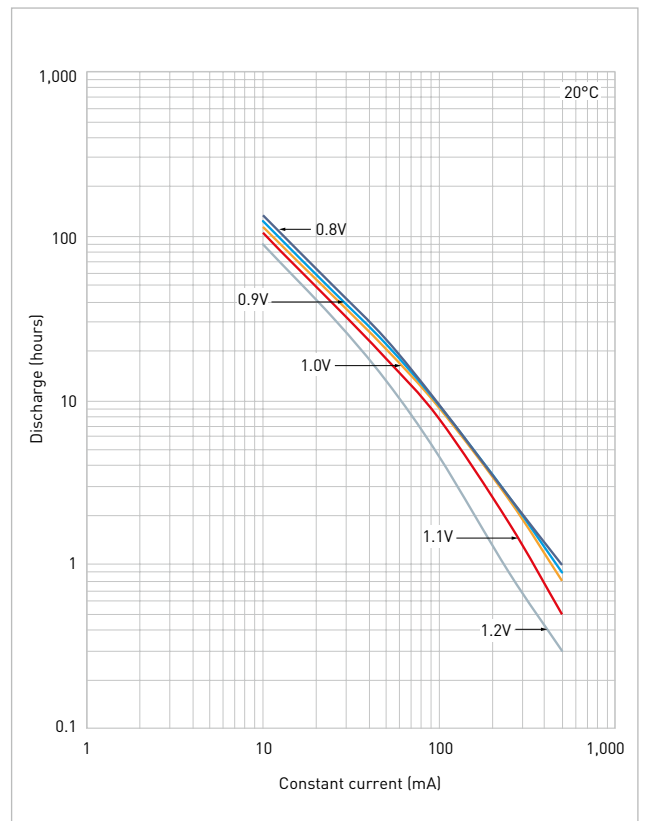
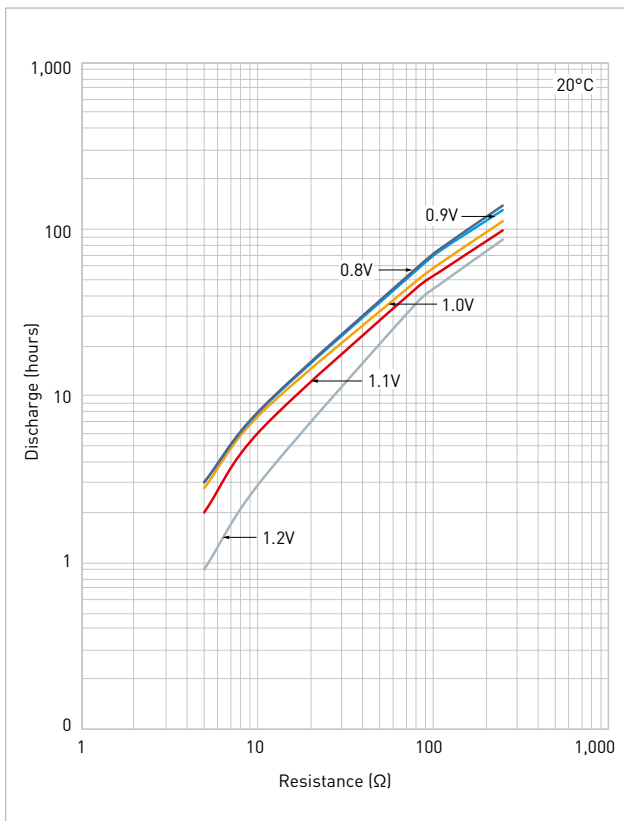
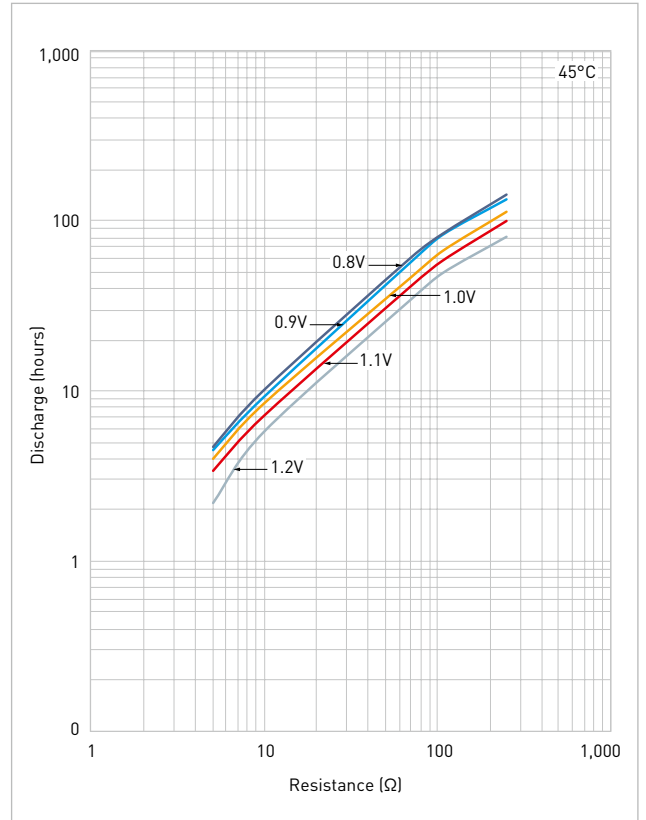
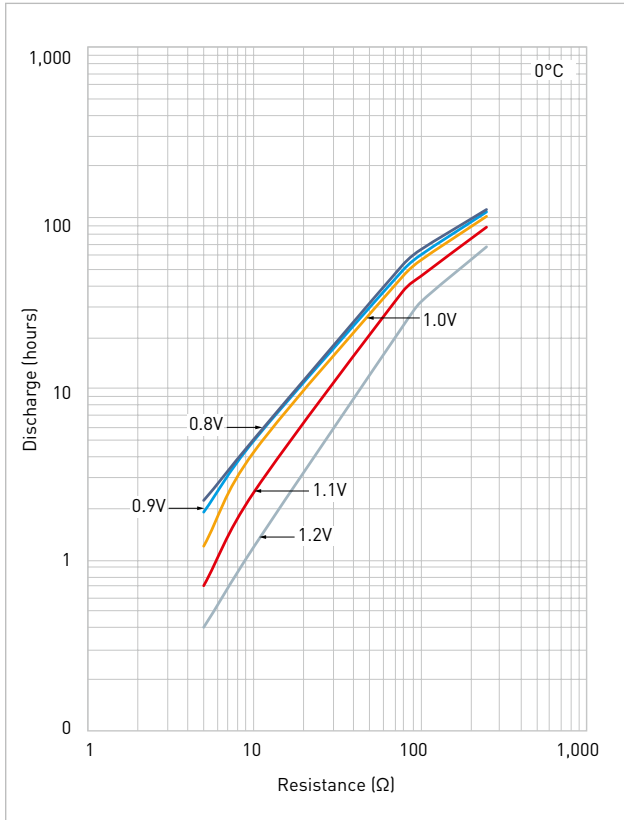

The information herein is believed to be correct. However no warranty is made, either expressed or implied, regarding the accuracy of the results to be obtained from the use of such information. Test results are strictly according to IEC conditions. Capacities of batteries depend on drain, temperature and cut-off voltage. Data are subject to change.