

ENERGIZER A27



ZEROMERCURY

Miniature Alkaline

Specifications

- Classification:** "Miniature Alkaline"
- Chemical System:** Manganese Dioxide (MnO₂)
- Designation:** N/A
- Nominal Voltage:** 12.0 volts
- Typical Capacity:** 27 mAh to 6.0 volts (rated at 20k ohms at 21°C)
- Typical Weight:** 4.4 grams (0.2 oz)

Industry Standard Dimensions

mm (inches)

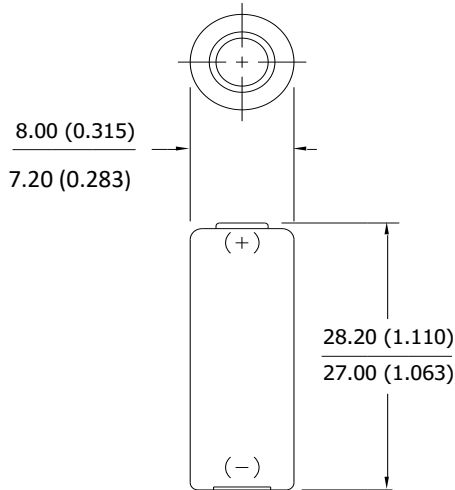

Designed for electronic applications which may require high rate pulses

Typical Discharge Durations

at 21°C

Schedule (time)	Drain (mA)	Load (ohms)	Cutoff Voltage		
			8.8V (hours)	7.2V (hours)	6.0V (hours)
Continuous	0.5	20K	49	54	55

Discharge Characteristics

Schedule: Continuous
Typical Load: 20K ohms (21°C)

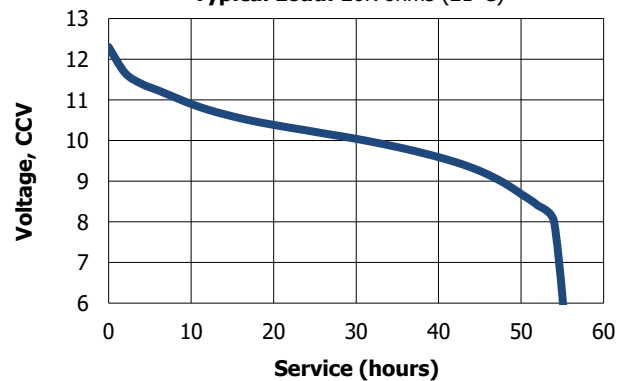

Important Notice

This datasheet contains typical information specific to products manufactured at the time of its publication. **Contents herein do not constitute a warranty and are for reference only.**